



EuroSwitch 5 inputs - 8 outputs

Compact and effective for large installations

Compact multiswitch equipped with 5 inputs (one terrestrial, and the four polarities of one satellite) and 8 user outputs.

Thanks to its great compactness and its optimized electronic design, it presents very low through and tap losses. This allows to reduce the number of amplifiers needed in the cascade and to obtain a better balanced signal in the users, even in large collective installations.

Can be used as a terminal (star topology) or as a cascade by using a simple switch. In addition, it incorporates a second switch that activates the TForce technology, which automatically adjusts the terrestrial signal and keep it constant despite variations in the reception.

RED compliant

Ref.	719503
Logical ref.	MSE58C
EAN13	8424450246719

Packaging info

Box 1 pcs.

Physical data

Net weight 362.00 g

Gross volume	0.86 dm ³
Gross weight	426.00 g
Width	137.00 mm
Height	120.00 mm
Depth	30.00 mm
Main product weight	362.00 g

Highlights

- Very compact in dimensions and weight, even in models with high number of users
- Very low through and tap losses
- High shielding (A class) thanks to its manufacture in Zamak
- Versatile: selector switch to shift between cascade and terminal modes
- Great isolation between inputs and outputs
- Equipped with the TForce technology, the terrestrial output level is automatically adjusted (TERR. AMP. ACTIVE) to the optimal level
- 10 dB Low Gain (LG) / High Gain (HG) switch for the attenuation of the satellite input signal for each 8-user group
- Several powering options: From the power supply, from the cascade through the satellite inputs or outputs, or directly from the satellite receiver (RECEIVER POWER ACTIVE)
- Low consumption under normal conditions. In addition, ECO mode reduces consumption as the number of connected users decreases
- Wide 12-18V power supply range, making it compatible with most existing systems
- Current circulation between all inputs and cascades
- Input and output colour identification
- 100% european design, quality, and manufacturing

Application example

Installation into a family-house (1 satellite)

The LNB and the multiswitch are powered from the user output by the STB, turning on the "RECEIVER POWER" switch.
A PSU is not required.

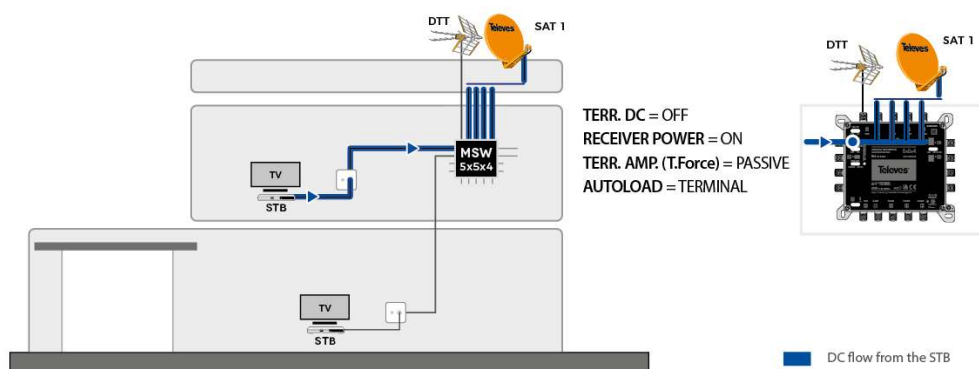

Installation into a small multi dwelling unit (1 satellite)

The LNB, terrestrial antenna and the whole cascade of multiswitches is powered by a single 3A PSU.
Thanks to "RECEIVER POWER" switched off, STBs are DC isolated from the cascade and protected against overcurrent.



Technical specifications : Ref. 719503

Number of inputs		5
Number of cascable outputs		5
Number of user outputs		8
Frequency range TERR.	MHz	88 ... 862
Frequency range SAT.	MHz	950 ... 2400
Input level TERR.	dBmV	20 ... 50
Input level SAT.	dBmV	5 ... 52
Through losses TERR.	dB	< 2
Through losses SAT.	dB	< 2
Tap losses TERR. Active	dB	0 ... 4
Tap losses TERR. Passive	dB	32
Tap losses SAT. HG	dB	2 ... 7
Tap losses SAT. LG	dB	12 ... 14
Output level 10Ch DVB-T	dBmV	18
Isolation H/V	dB	> 50
Isolation users	dB	> 30
Powering	Vdc	12 ... 18
Max. current (PSU - TERR ACT.)	mA	65 ^{*1}
Max. current (PSU - TERR PAS.)	mA	5
Max. current (STB)	mA	85
Operating temperature	°F	23 ... 113
Protection index (IP)		20